

# FLIGHT PROGRAM F3C R/C HELICOPTER

## COMPULSORY MANOEUVERS

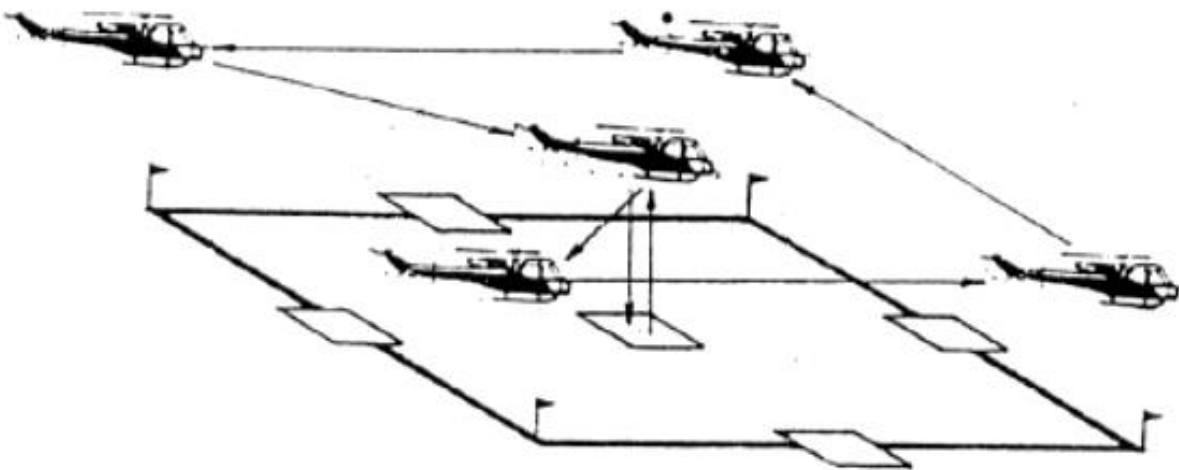

1. HOVERING 'M' K=6

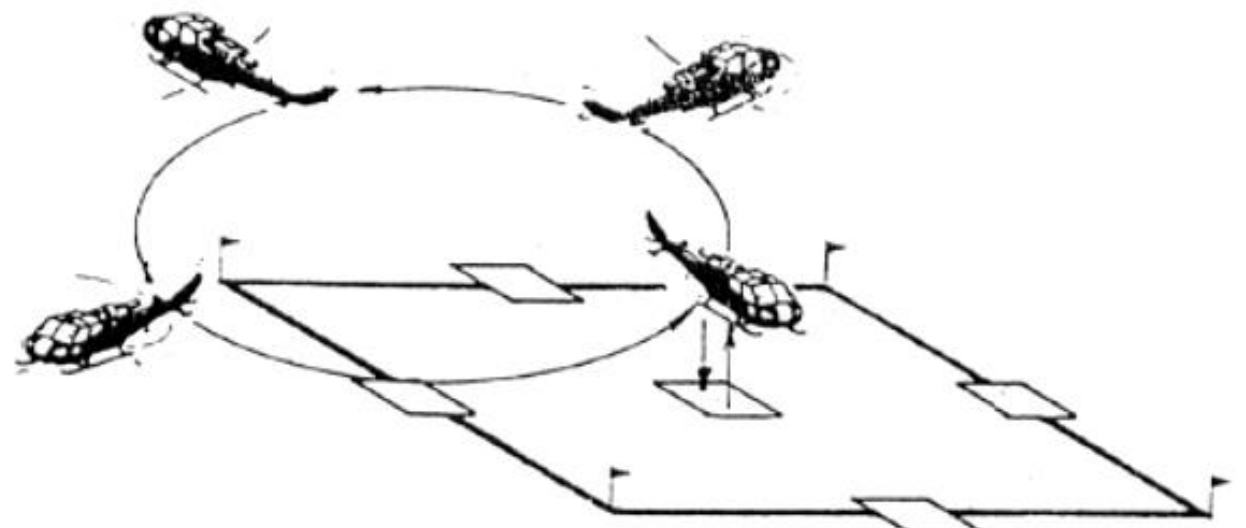

2. HOVERING CIRCLE K=6

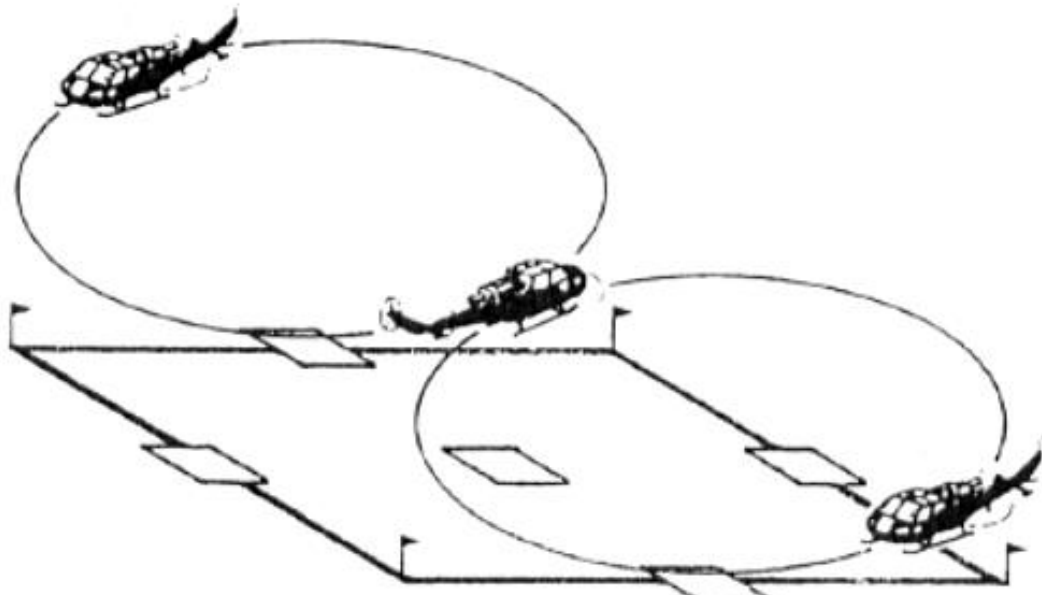

3. HORIZONTAL EIGHT K=8

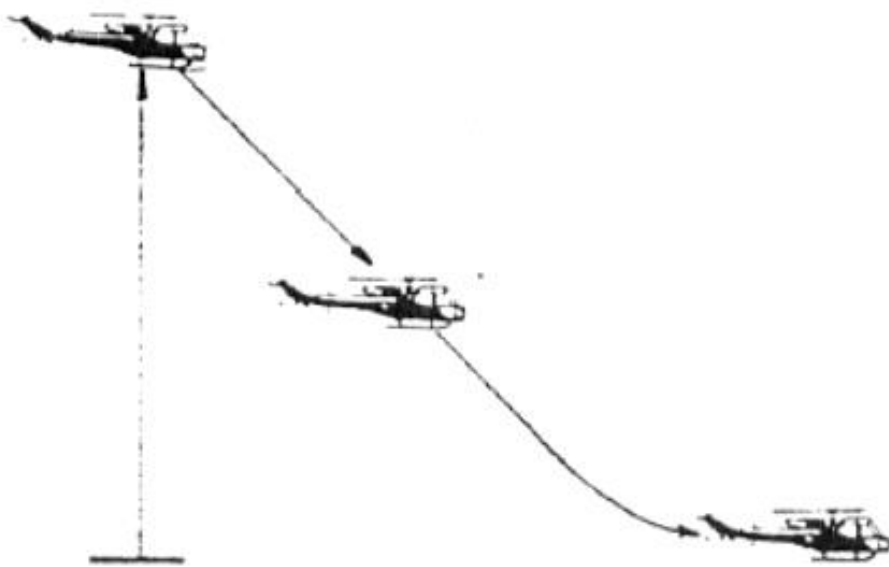

18. AUTOROTATIVE DESCENT & LANDING K=10

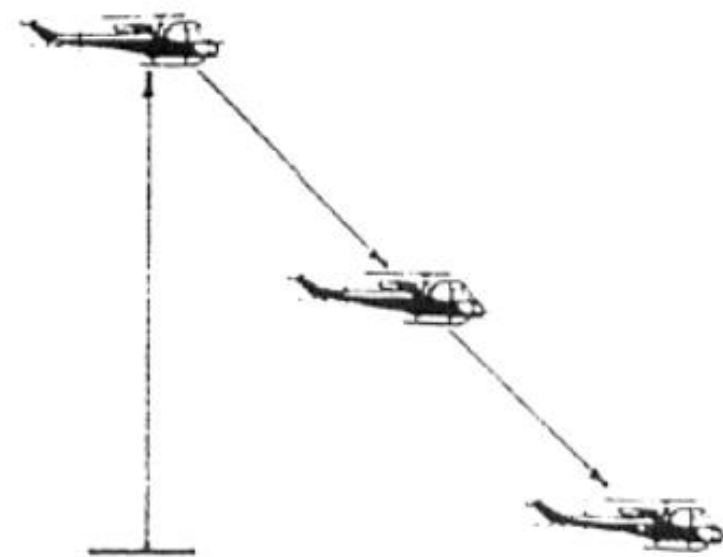

19. LANDING K=6

## OPTIONAL MANOEUVERS

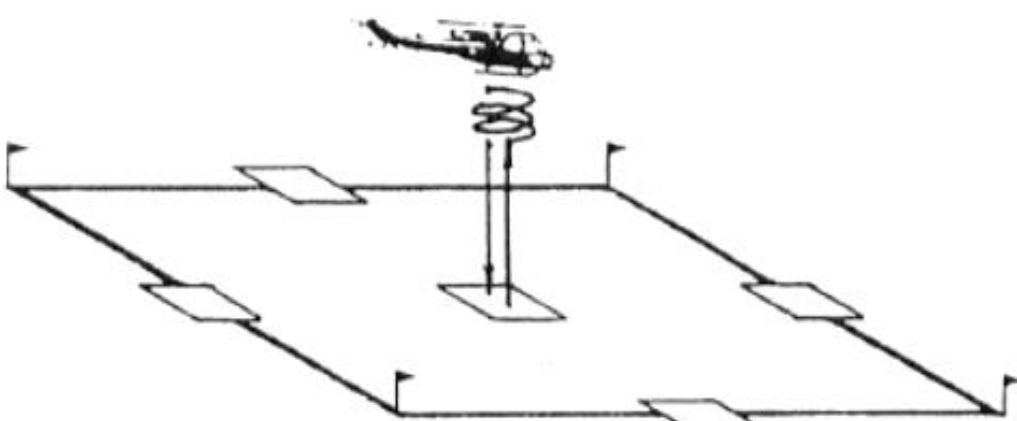

4. DOUBLE PIROUETTE K=8

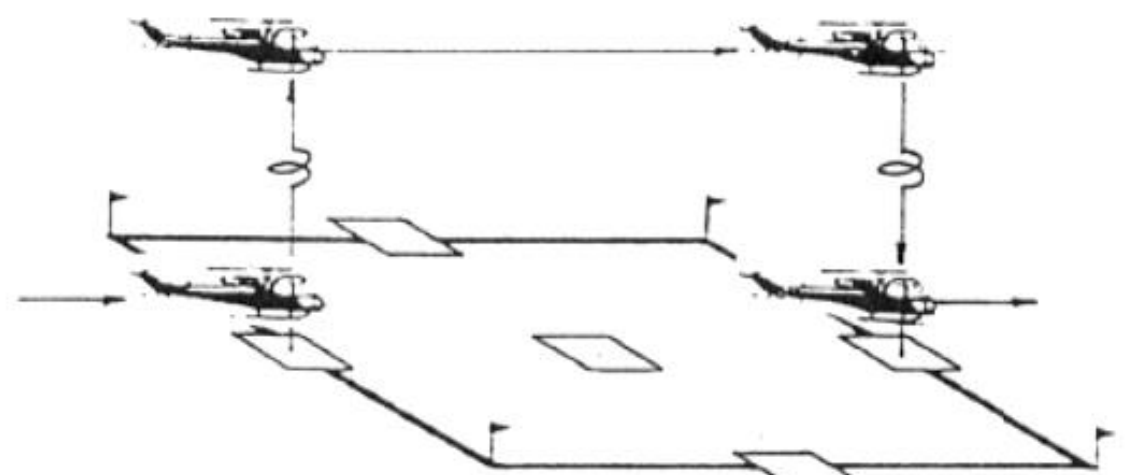

5. TOP HAT K=8

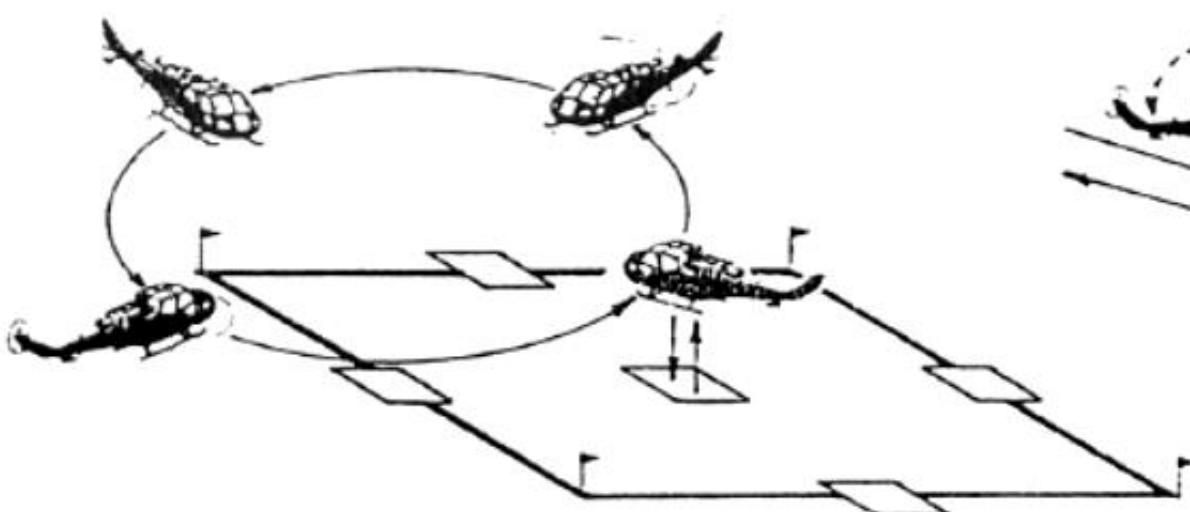

6. NOSE-IN CIRCLE K=9

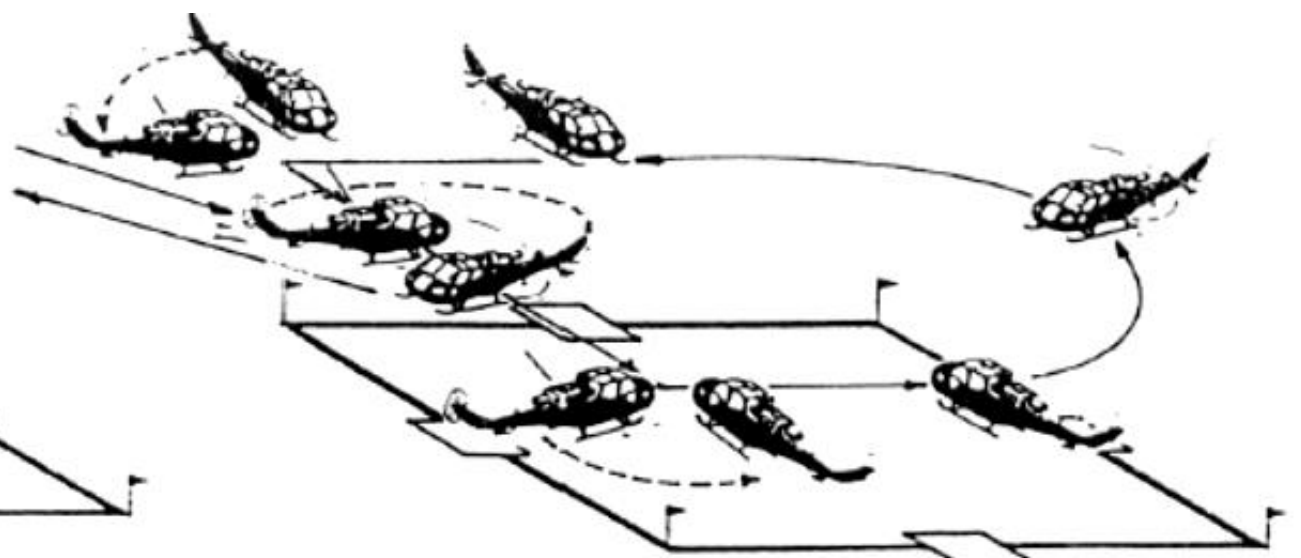

7. SHOVEL K=9

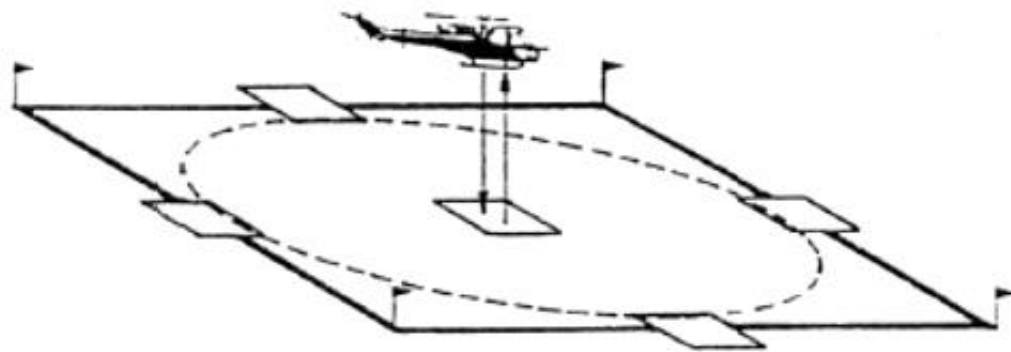

8. PILOTS PROMENADE K=8

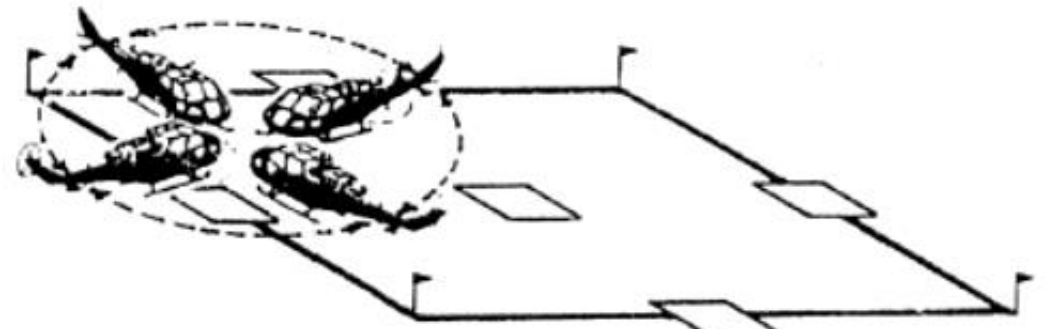

9. FOUR POINT PIROUETTE K=9

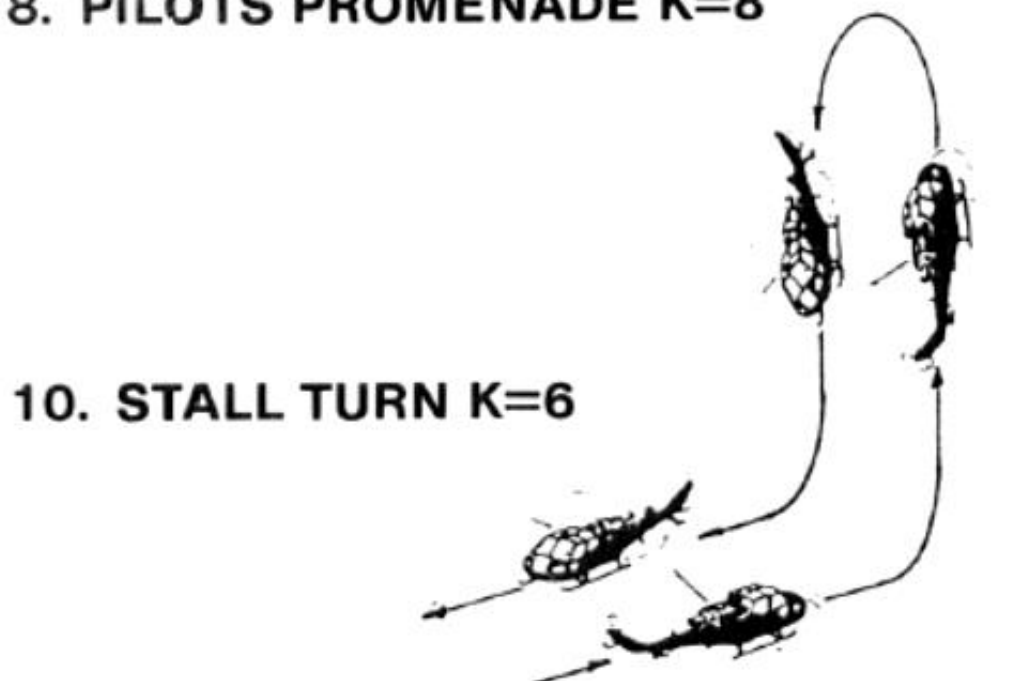

10. STALL TURN K=6

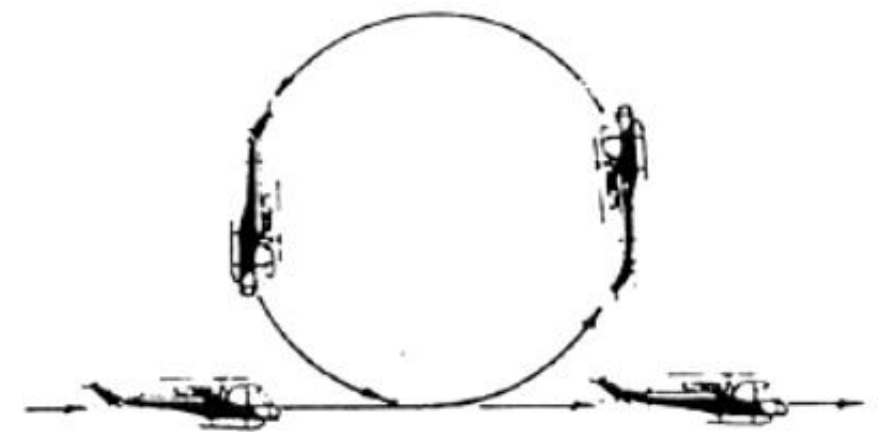

11. LOOPING K=8

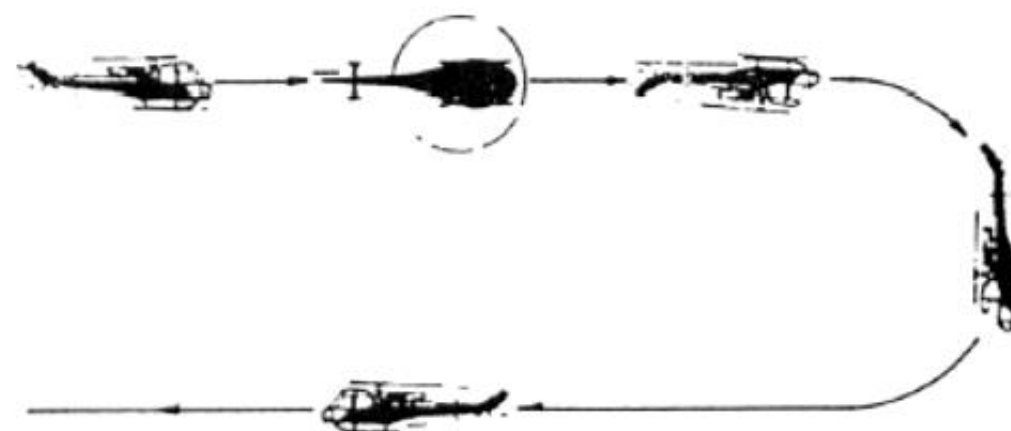

12. SPLIT-S K=8

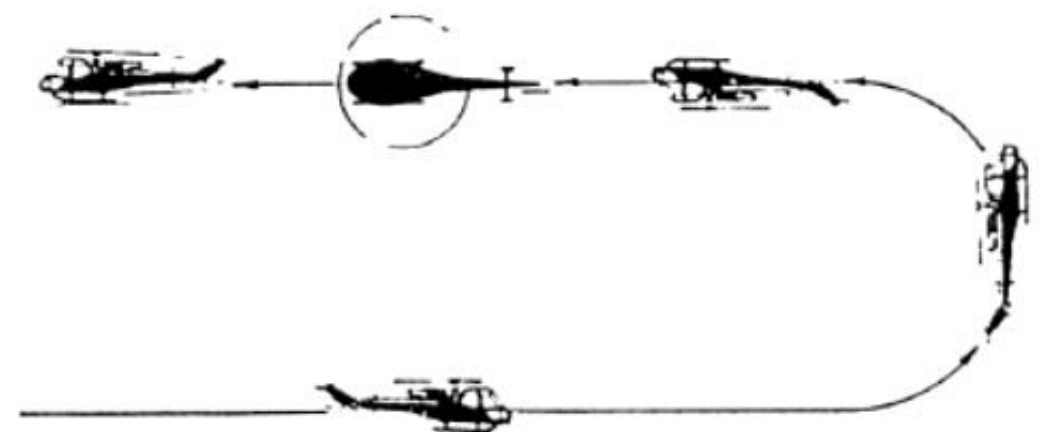

13. IMMELMANN K=8



15. ROLL K=9

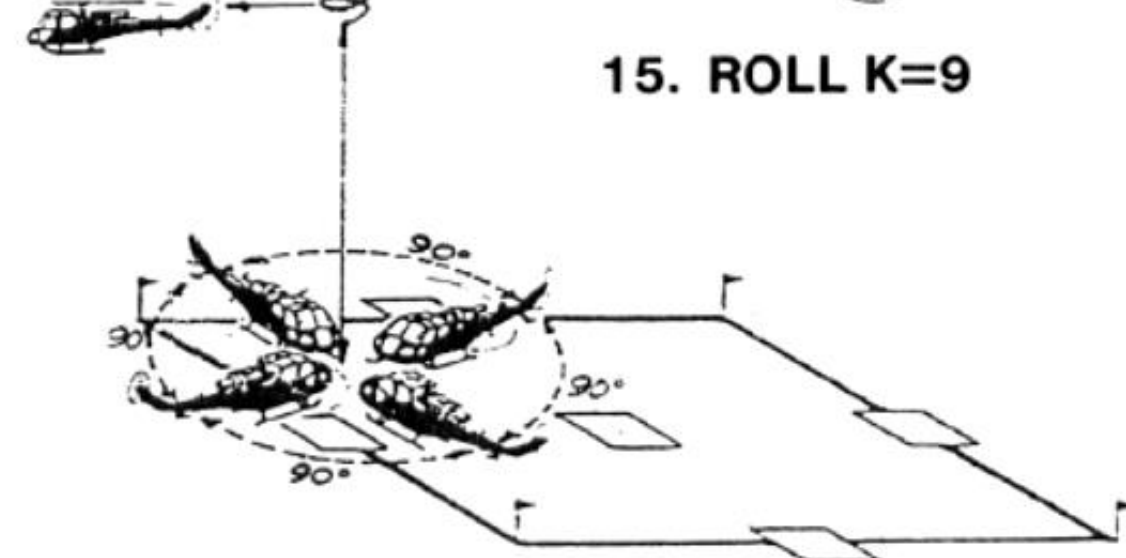

14. OBSERVATION K=10

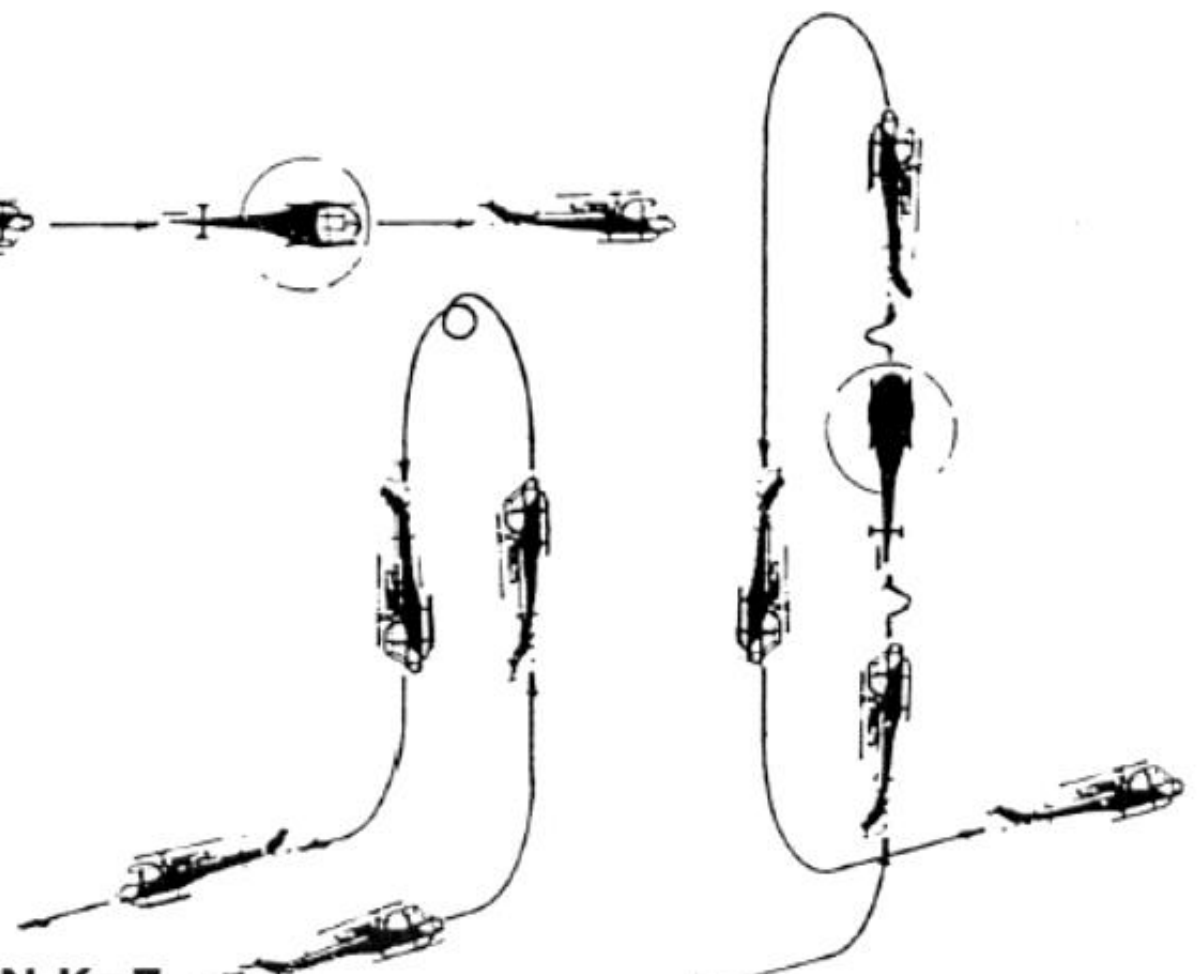

17. 540 STALL TURN K=7

16. ROLLING STALL TURN K=9