

FIGURE 5D-P: F3C MANOEUVRE SCHEDULE P

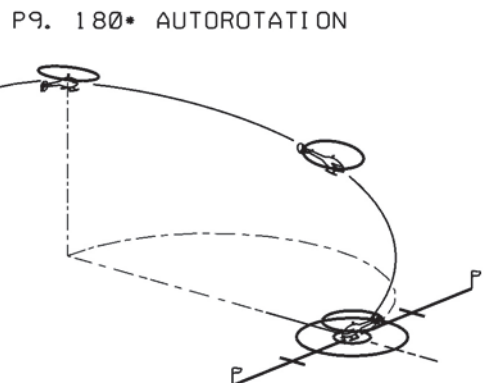
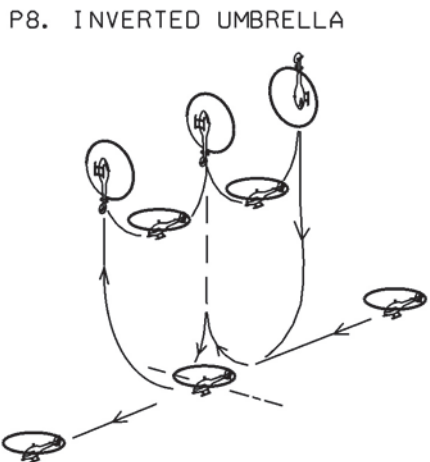
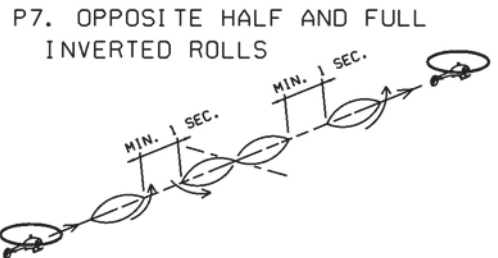
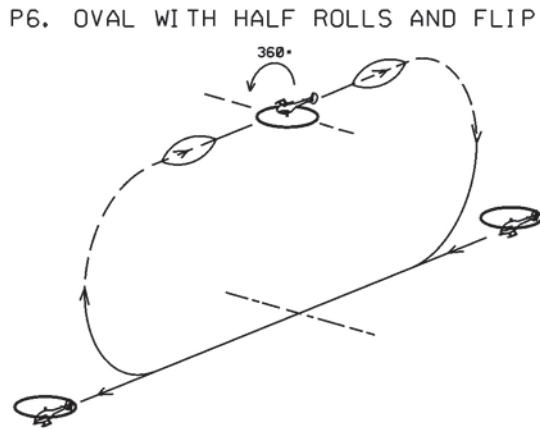
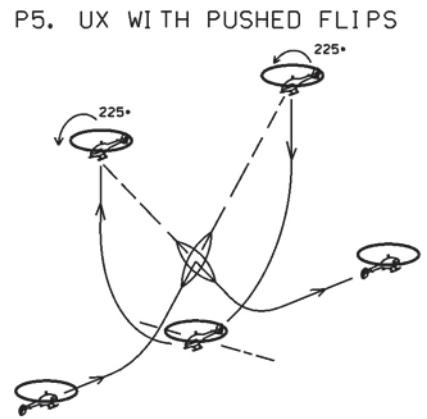
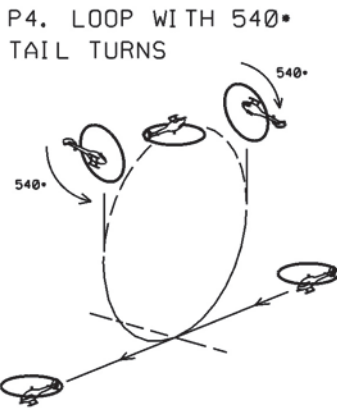
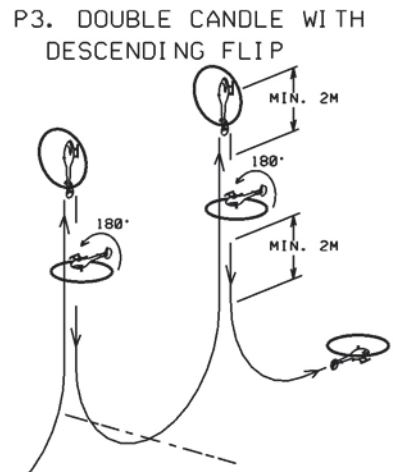
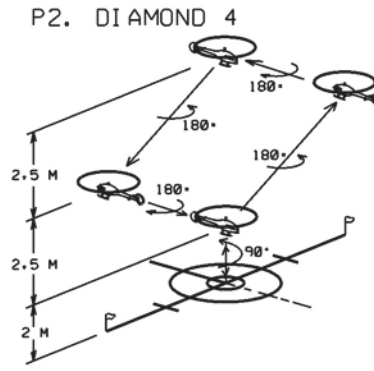
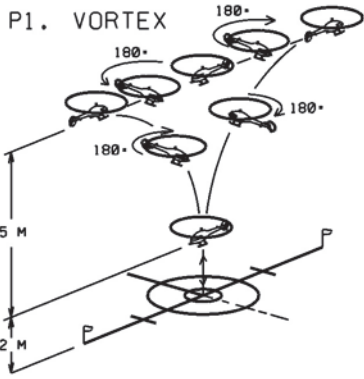
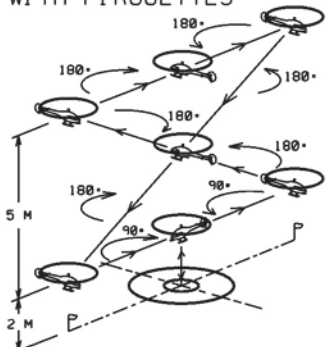
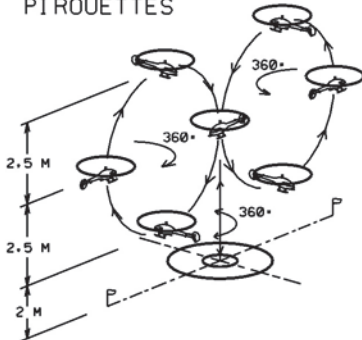

FIGURE 5D-SF/F: F3C MANOEUVRE SCHEDULE SF/F

F1. VERTICAL HOURGLASS WITH PIRQUETTES



F2. LAID EIGHT WITH PIRQUETTES



F3. CANDLE WITH 360° TAIL TURN AND 180° PUSHED FLIP

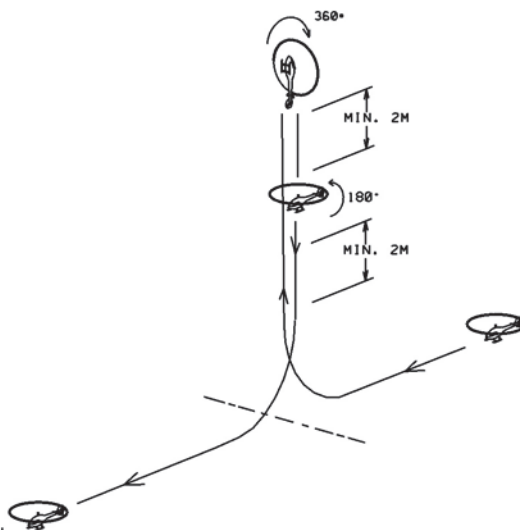

F4. DOUBLE CANDLE WITH HALF FLIPS AND HALF ROLLS

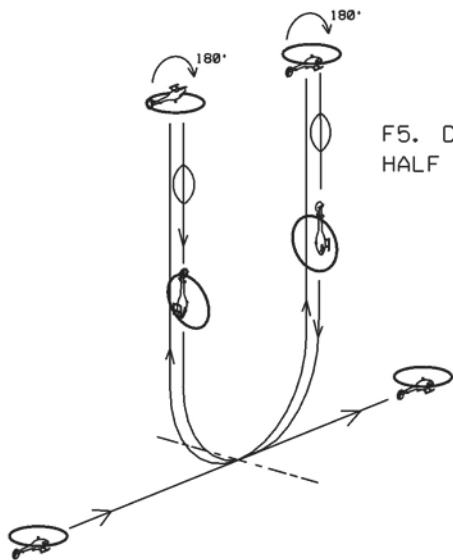

F5. DOUBLE STALL TURNS WITH HALF ROLLS AND FLIP

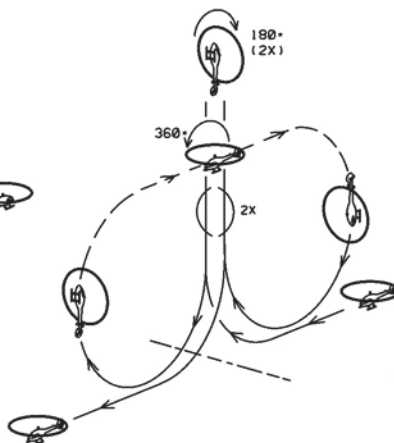

F6. THREE OPPOSITE ROLLS

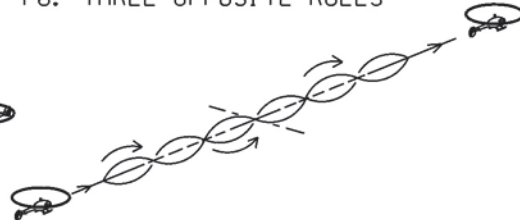

F7. INVERTED UMBRELLA WITH HALF ROLLS

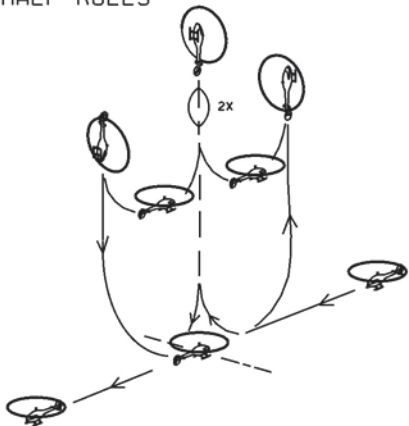

F8. AUTOROTATION WITH FLIP AND TWO 90° TURNS

