

HELP FOR TRAINERS AND PILOTS

P3-Double Candle-2020-2021

By Roger Lacôme



Introduction :

As you can see with the two hovering figures, the helper function (caller) during a competition and that of trainer, are two very distinct functions.

The helper (caller):

The mechanic / caller must announce the start, finish and name of each maneuver, and should inform the pilot of the wind direction, the remaining flight time, the proximity to prohibited areas and intrusions into the flight area.

The trainer:

A trainer is a purely coaching function,, it must be positioned in different places (especially for stationary figures) in order to be able to check all the particular points of each figure.

Another important point that the majority of pilots forgot during aerobatic tricks is that the flight plan must be parallel to the judges' line.

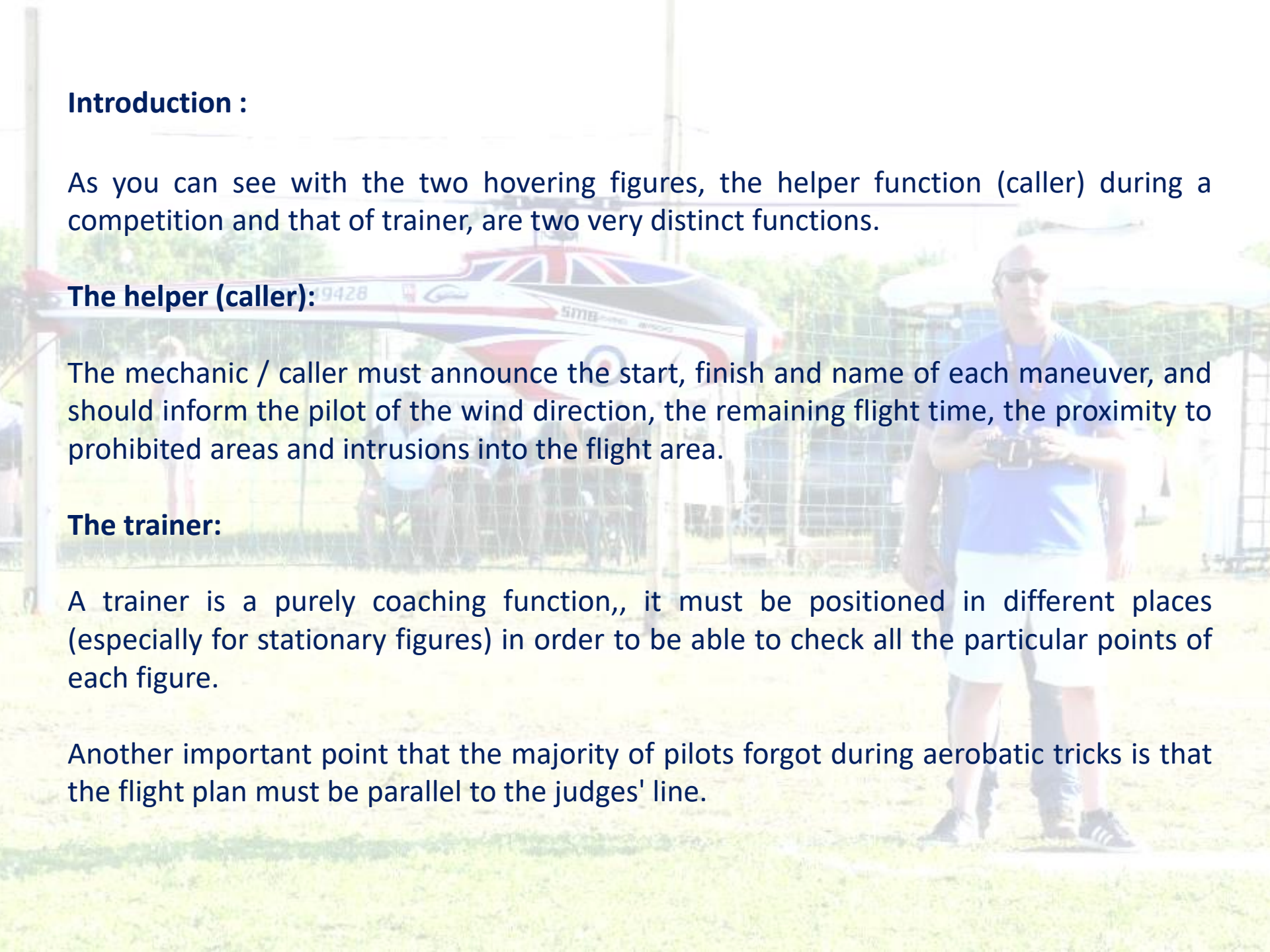

Note which concerns all aerobatic figures:

- First point that many pilots forget; compliance with the depth of the flight plan which must not exceed 100m from the judges' line, beyond this the penalty is 1 to 2 points.
- Second point that practically no pilot cares about and that it is imperative to respect; the centering of the figure and this does not only concern the part of the figure which crosses the central line, example: with the P3-Double candle:
 - The two vertical ascents must be at the same distance from the center line.
 - The same goes for P5: UX
 - Same for P8: Inverted umbrella with regard to the two mounted at the ends.
- Third point, still much less respected, the axis of the flight plan which must be parallel to the judges' line, that is why during training sessions, you must first start with an empty passage to properly visualize and respect this axis, what some pilots do during competit

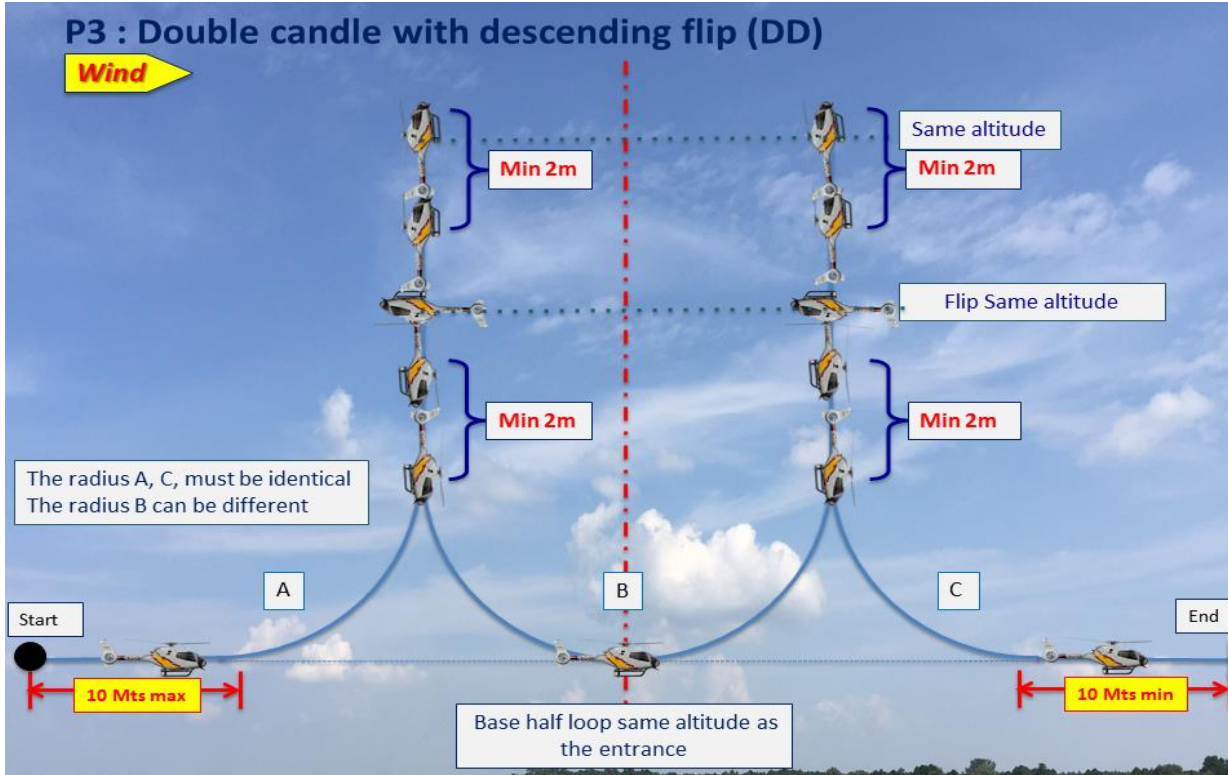

P3: Double candle with descending flip (DD)

K=1.0

MA flies straight and level for a minimum of 10 m and pulls up into a vertical ascent.

After a nose up stop MA flies backwards vertically for 2 m minimum performs a half pulled travelling flip, descends vertically for a minimum of 2 m, performs a centered half loop and ascends vertically.

After a nose up stop MA flies backwards vertically for 2 m minimum, performs a half pulled travelling flip, descends vertically for 2 m minimum and then pulls into horizontal straight and level flight for a minimum of 10 m.

Note 1: The 2 flips must be made at the same altitude.

Note 2: The bottom of the half loop must be at the same altitude as when entering the figure.

Before making comments, it is necessary to dissect this figure:

- I remind you that the radii of the entry and the end quarter of the loop must be identical, see the drawing below.

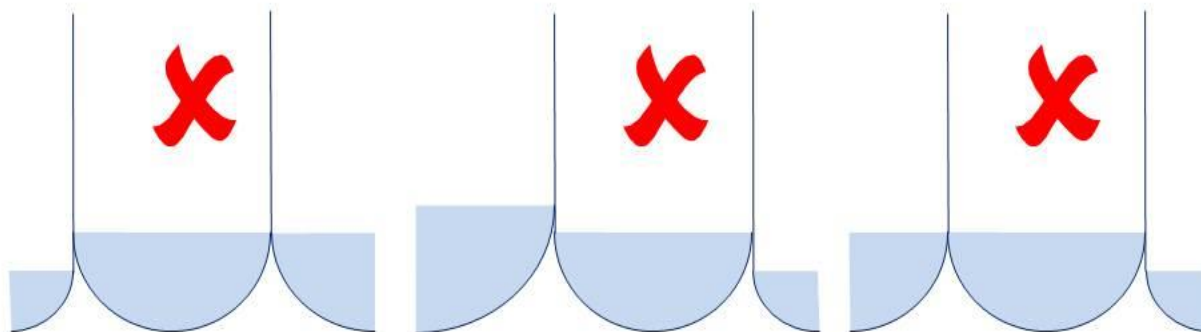
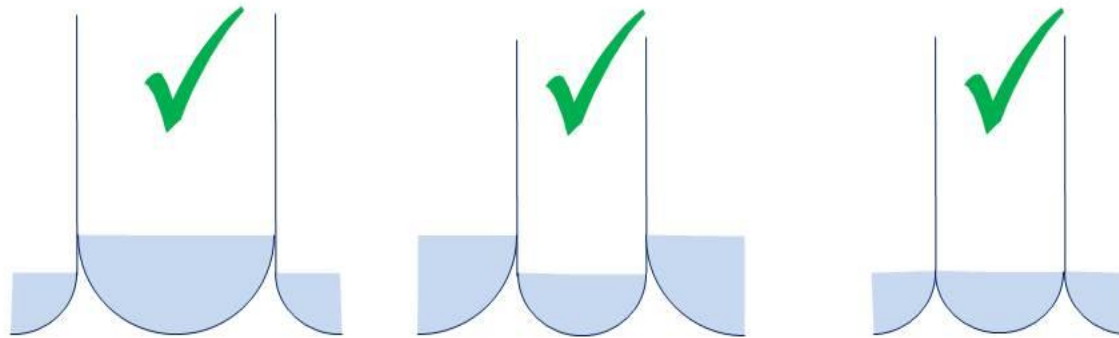

- From here, it must be understood that the greater the radius of the quarter of end loop (and therefore that of the beginning of figure) will be large, the higher the helicopter will have to ascent, because the total length of the descent includes, the descent of 2m, the translated flip and the descent of 2m, this length will always be the same, see the drawing below.

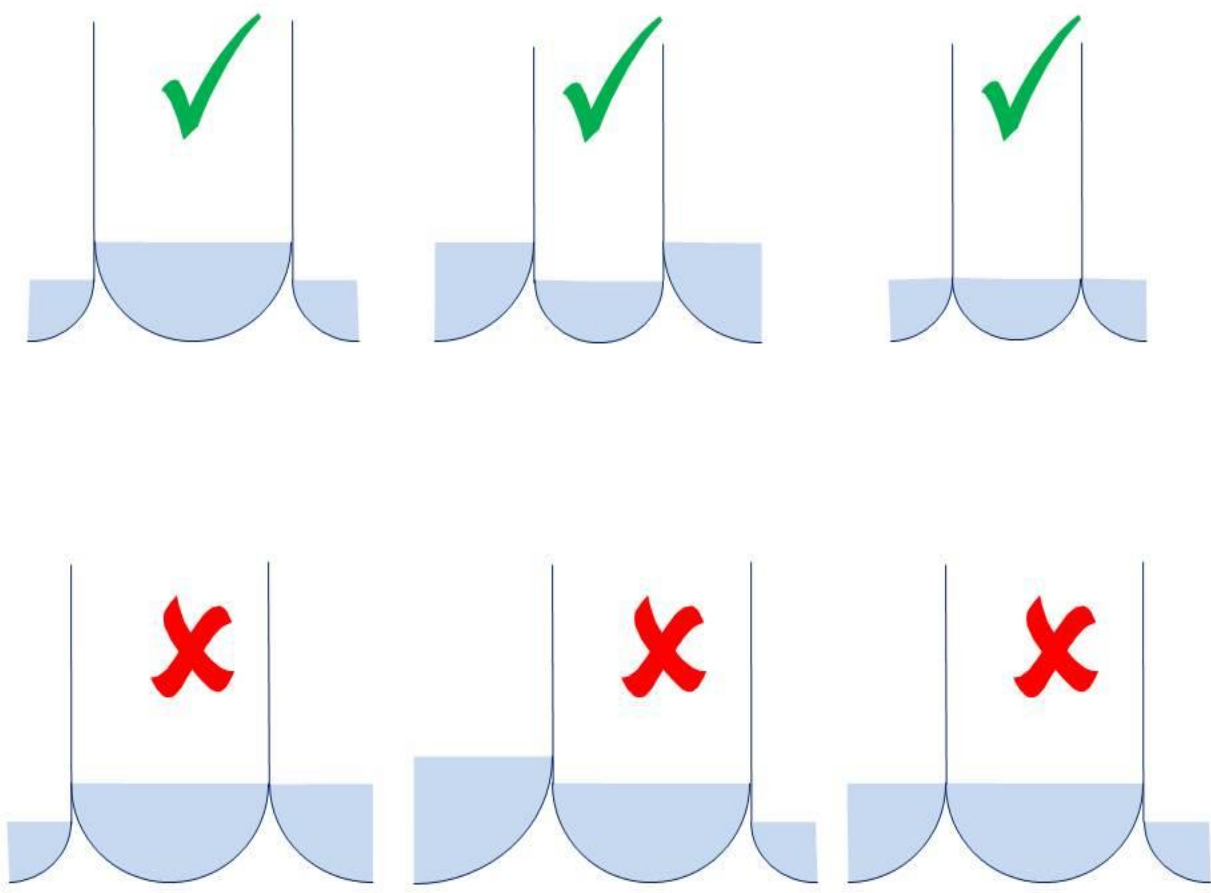

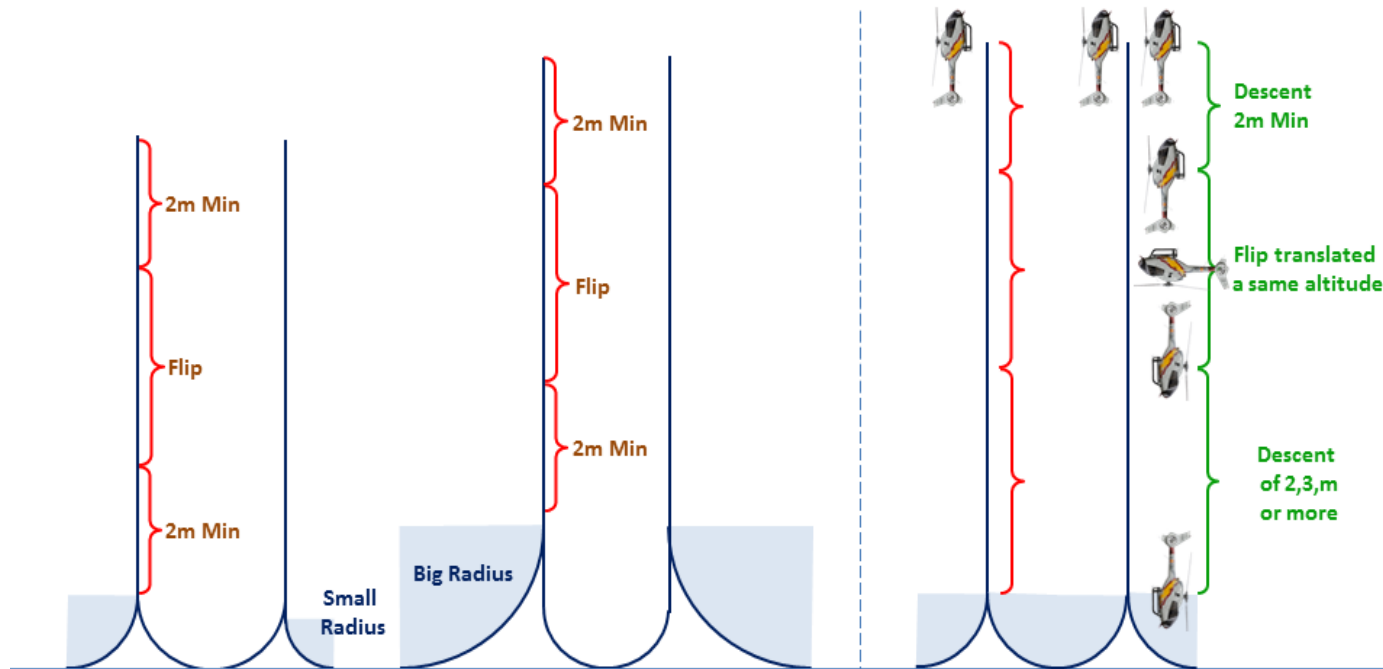

The bigger the radius, the higher you have ascent

It is possible to do:

- Descent 2m
- Flip translated a same altitude
- Descent of 2,3m or more

There are two « schools », for example with Ito, who makes the loop quarter with a relatively small radius and therefore needs to ascent less high, while Stefan WASCHMUT makes a quarter loop with a slightly larger radius, but he ascents higher.

The flight of Ito requires a very good level of piloting because recovery at the end of the figure after the quarter loop is much more difficult to achieve correctly. By cons, not only is it easier to make a medium radius like Stefan and more is much more beautiful, but you have to ascent higher.

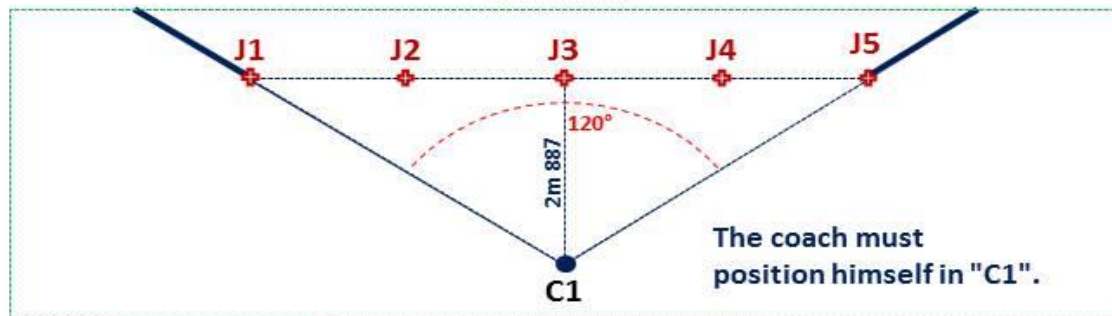
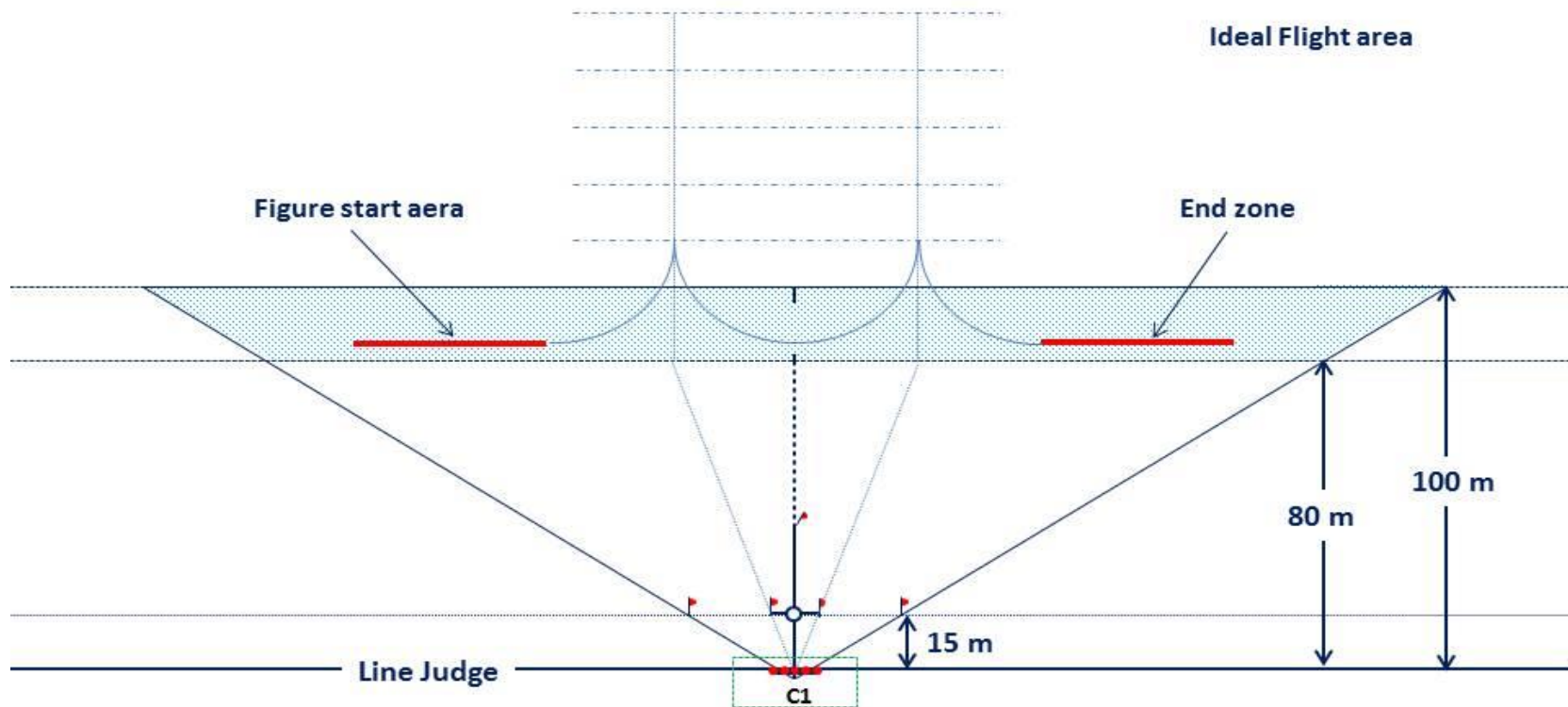

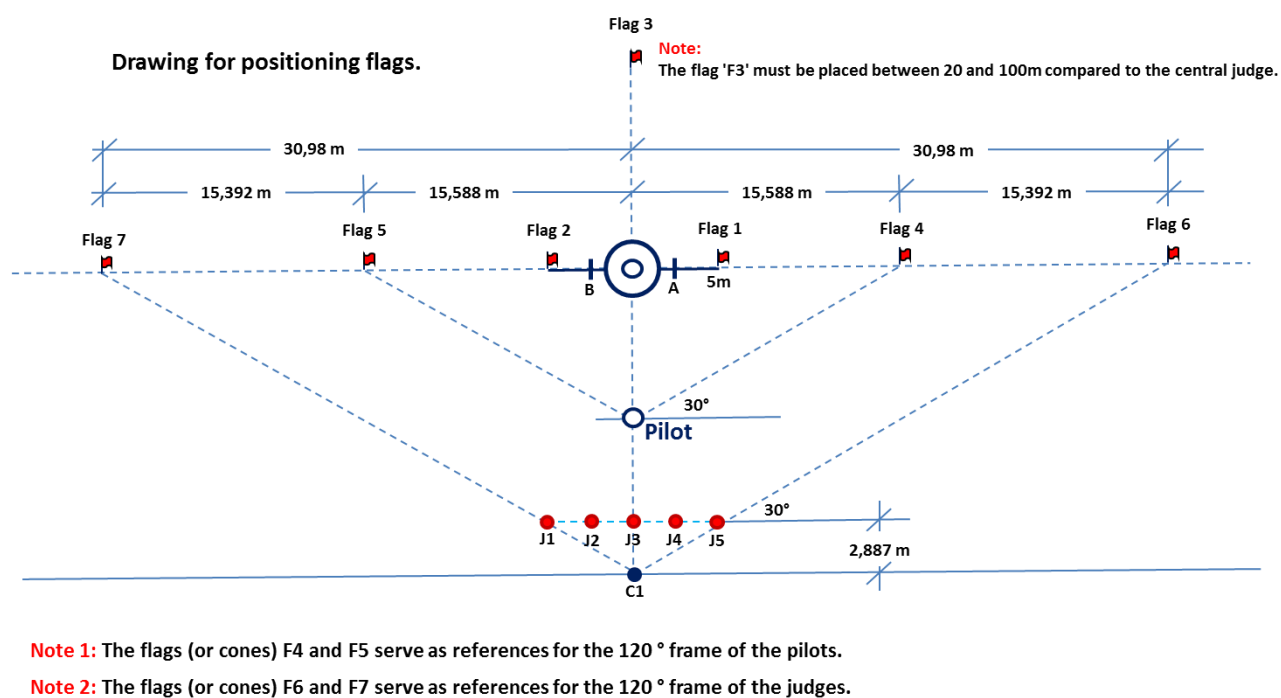

What is the best depth for the execution of this figure?

It's not necessary to fly too far, a depth of 80m is largely sufficient provided that the radius of the "U" is relatively small.

Where should the start of the figure be given?

The area is wide enough because it depends on each subsequent pilot if the radius of the quarter loop is small or large.

A point that no pilot or trainer takes into account while it's a very important point, where the ascent should be done if you do not want the figure to come out of the frame after the descent at the end of the figure?

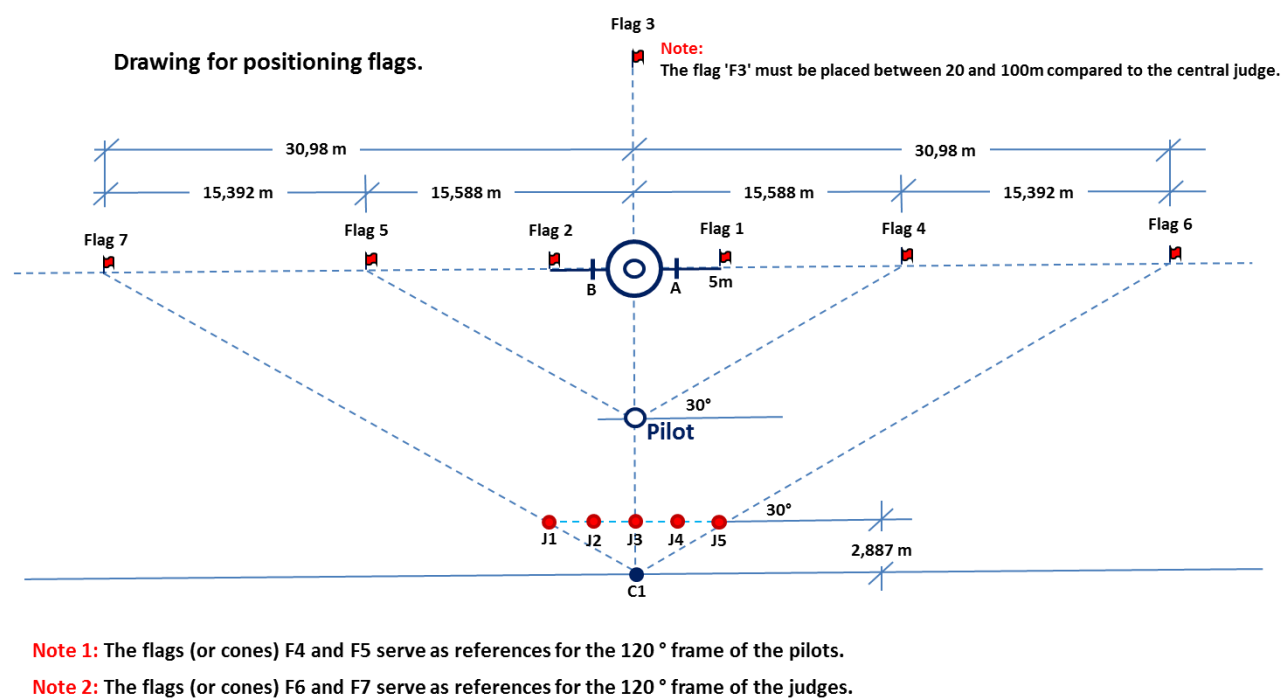

Where should the trainer position himself for aerobatic tricks?

The trainer must position himself behind Judge 3 at location C1. (at 2m887).

Why ?

Because from this position he can accurately see the 120° frame on both the left and the right side and at the same time the center line.

Another advantage, using flags F1 and F2 (and / or F4 and F5), it can check if the centering of the figure is correct.

The ascent should be done approximately in line with the F2 flag.

It must be understood that the smaller the of "U" radius, the less risk of exit from the frame.

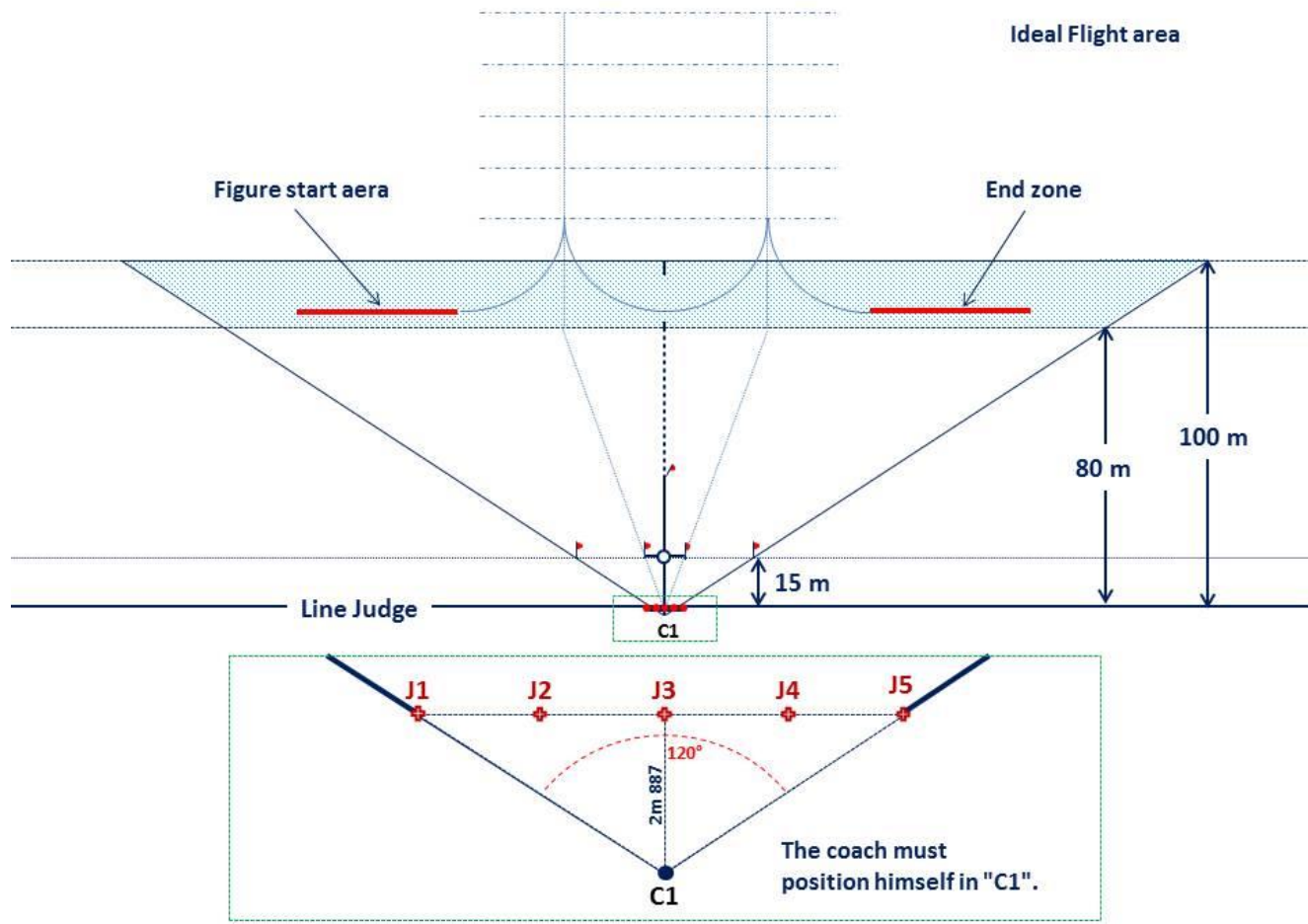

Plus the ascent will be on the left of the F2 flag, the greater the radius of the half-loop of the "U" and the higher the second ascent will be shifted to the right with the consequence of increasing the risk of exit from the frame.

If the trainer is behind the pilot, then it is absolutely necessary that the ascent is done to the right of the flag F2, almost in the extension of the mark "B".

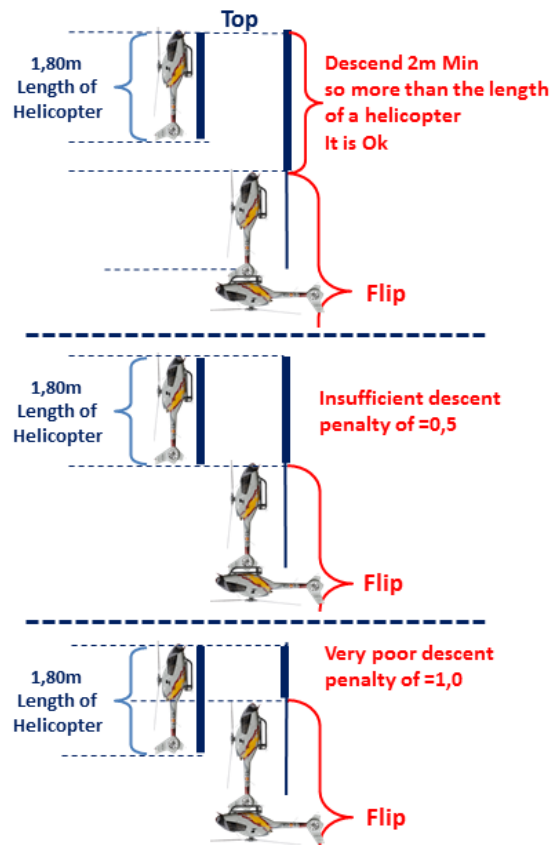

Note: If no downhill penalty of=1,5

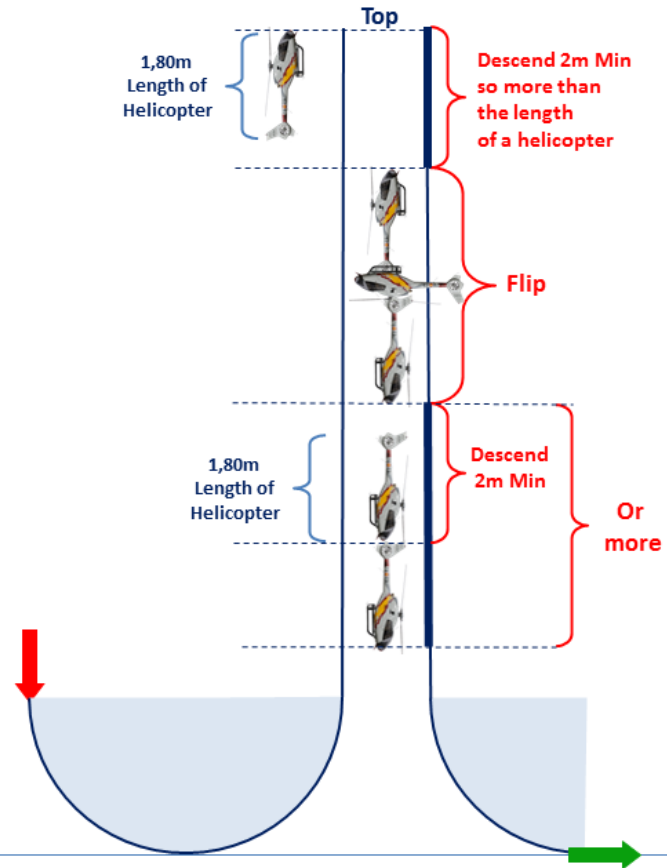

Another technically important point concerning descents of 2m minimum:

Knowing that a helicopter measures an average of 1.80m and that when the helicopter finishes the ascent, it must go down at least 2 meters minimum, so for a distance longer than a helicopter. It is imperative that this point be respected!

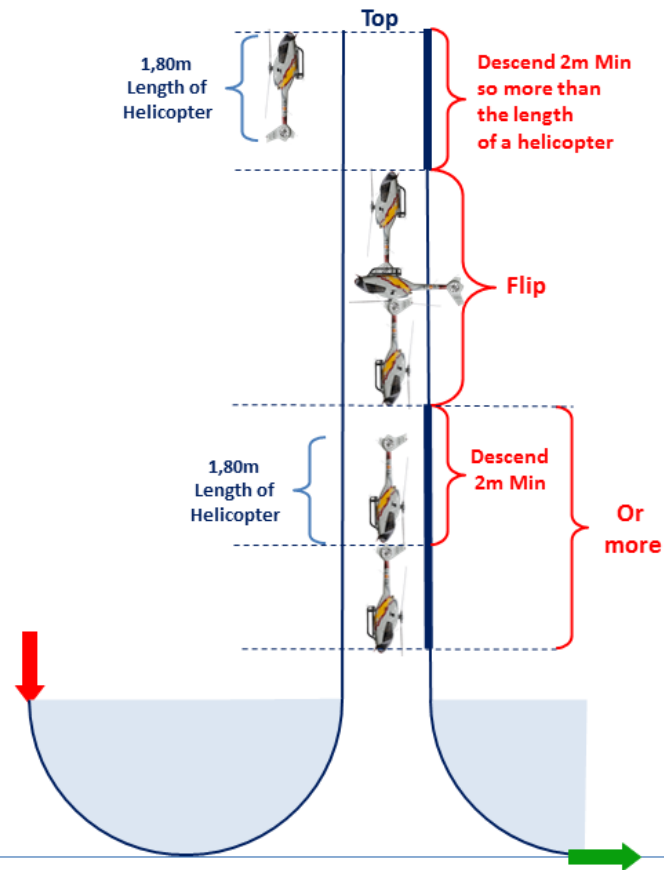
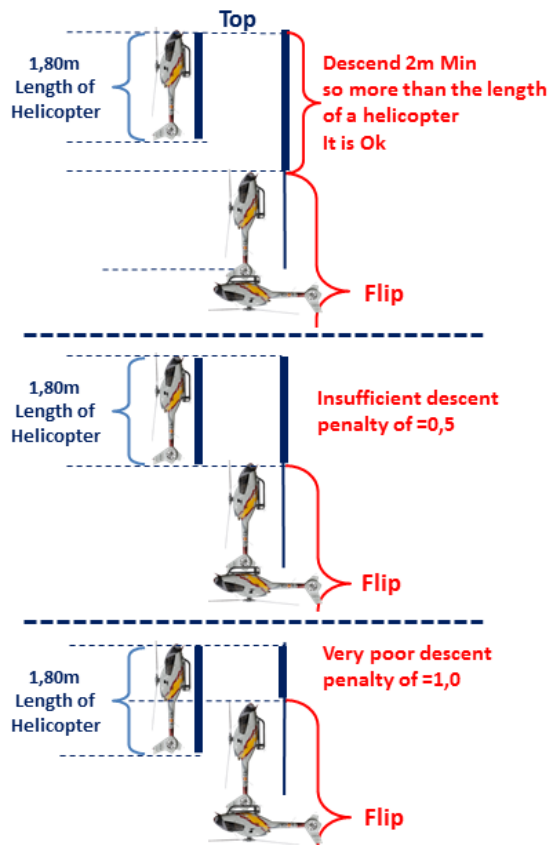

Note: If no downhill penalty of=1,5

After, you have to do a flip translated, but be careful not to do too slowly because otherwise it may not have room to perform the second descent of 2 meters minimum.

Still concerning the flip, it must remain in the straight trajectory of the descent and not shift to the right or left.

To execute these three phases of the descent, it is imperative that the helicopter ascent as high as possible, otherwise it will not be possible to execute all the phases correctly.

Then, we must not forget that the base of the "u" must be at the same altitude as the figure entry.

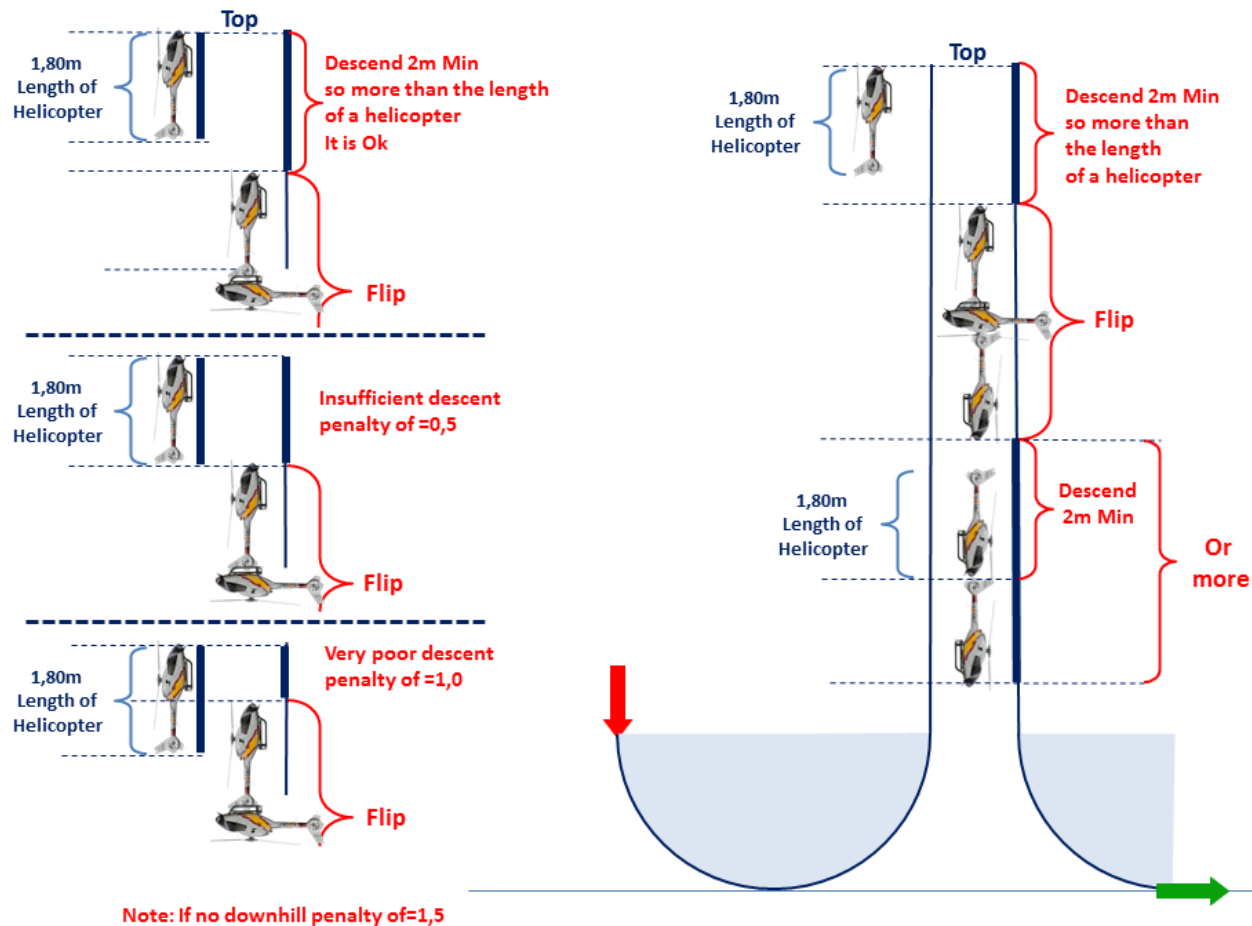

Same comments for the second ascent that must stop at the same altitude as the first and must be done symmetrically, so at the same distance as the first ascent from the center line.

Finally, as with all aerobatic figures, the output must be made at the same altitude as the figure entry and on the same plane.

I will not repeat this last point which is applicable to all figures.

Note: It is clear with this figure that the role of the coach is very important.

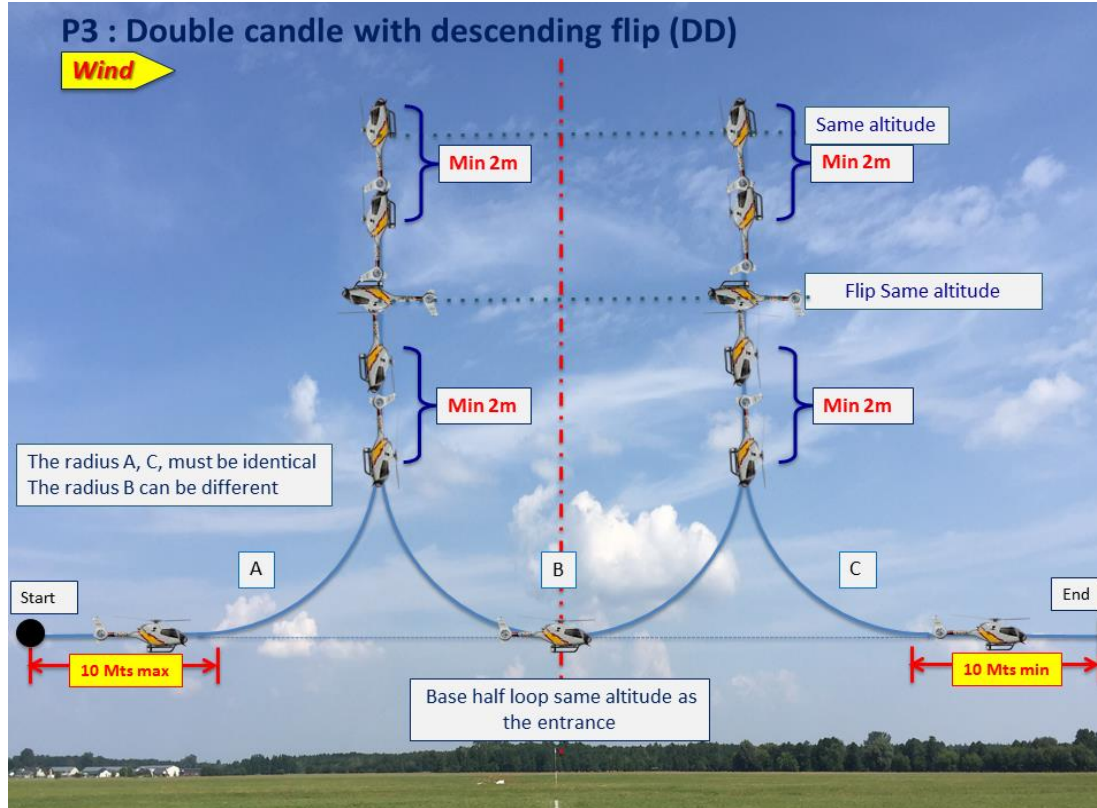

Summary of what needs to be done:

- A quarter of figure input and output loop with an identical radius.
- A vertical ascent as high as possible, it will never be too high.
- A descent in reverse of at least 2m minimum is very important.
- A translated flip not too slow because otherwise it takes too much vertical distance.
- A descent of 2 meters minimum or more.
- The base of the half-loop of the "U" must be at the same altitude as the figure entry.
- The second ascent must be at the same altitude as the first.
- Same comments for the second descent taking into account that the flip must be executed at the same altitude as the first.
- An exit of figure at the same altitude as the entry and on the same plane.

P3 : Double candle with descending flip (DD)

Wind

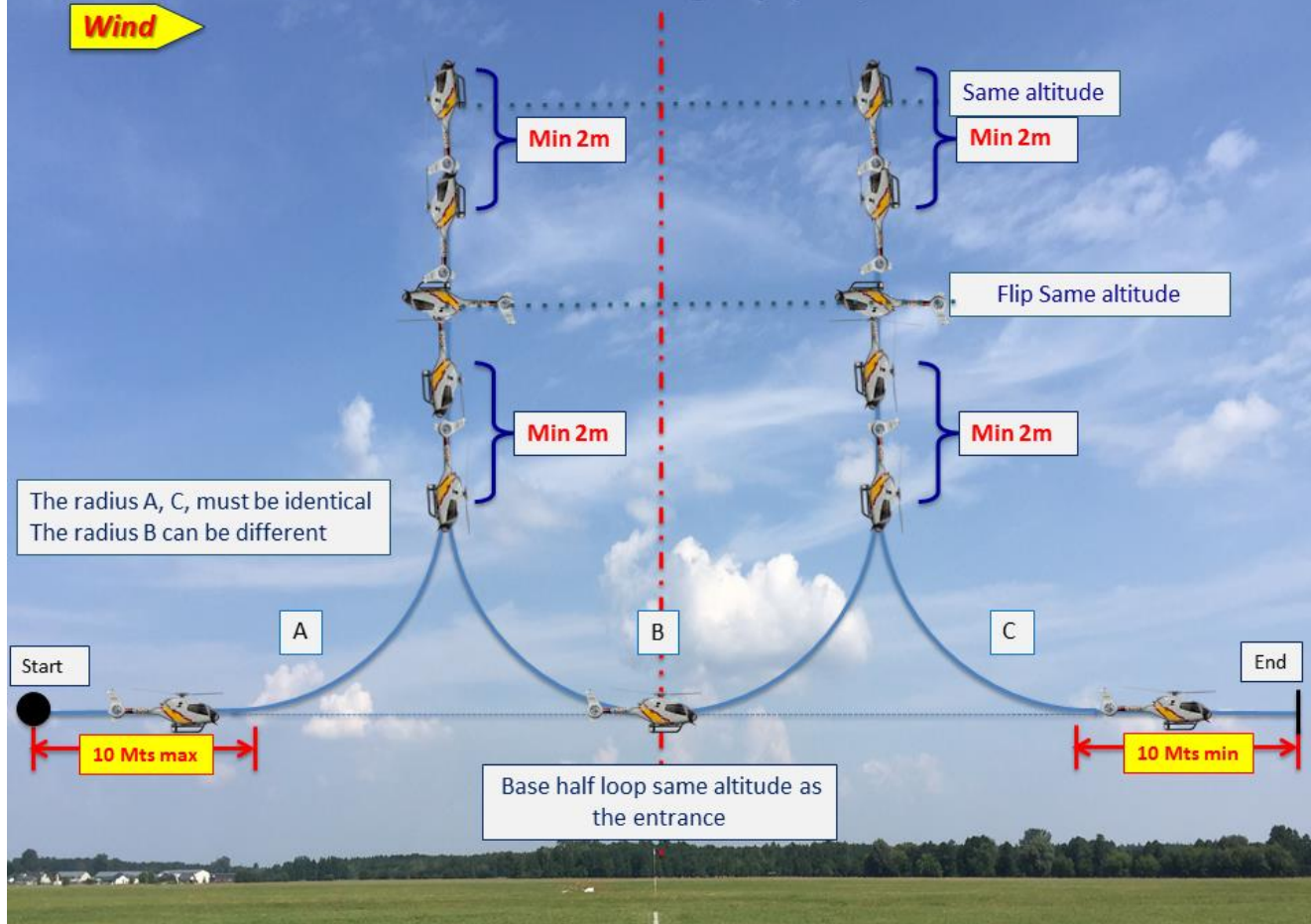

Thanks for your interest

Training by Roger Lacôme
Power Point by Eladi Lozano
For Subcommittee the F3CN CIAM-FAI